

Fujitsu

**Zaawansowane
rozwiązania i
produkty IT „po
japońsku”**

VIII Konwent Informatyków i Administracji Pomorza i Kujaw

18-19 czerwca 2015 w Ciechocinku

Adam Dyszkiewicz

Senior BDM Servers&Storage, Fujitsu

FUJITSU

shaping tomorrow with you

**Human Centric
Innovation**

Fujitsu - Kim jesteśmy



- Firma IT Nr 1 w Japonii
- Dostawca usług IT Nr 3 na świecie
- Przychody ponad 50 mld US \$
- Fujitsu zostało założone w 1936 roku
- Zatrudniamy ponad 170,000 ludzi , którzy wspierają klientów w ponad 100 krajach
- **Inwestujemy 2,8 mld \$ w R&D rocznie**
- 8 500 pracowników w dziale R&D, w tym ponad 200 w Polsce
- Fujitsu posiada ponad 100 tys. Patentów
 - Nr 7 w ilości rejestrowanych patentów w Japonii
 - Nr 11 w ilości rejestrowanych patentów w USA (np. przed Apple, HP, GM, Intel...)



Fujitsu Polska



1999 - Fujitsu Siemens Computers

2009 - Fujitsu Technology Solutions

2014 - Fujitsu posiada blisko 1000 pracowników w Polsce

Fujitsu Warsaw
100+

GDC Service Desk
Łódź
700+

SSC Łódź
80+

R&D Łódź
100+

Portfolio Fujitsu...



FUJITSU Client Computing Devices



- Unikalny wybór światowej klasy technologii komputerowej



CELSIUS

Stacje robocze / Mobilne stacje robocze

LIFEBOOK

Notebooki i Tablet PC

STYLISTIC

Tablet PC

ESPRIMO

PCs

FUTRO

Smart Zero Clients

FUTRO

Thin Clients

Urządzenia mobilne

Urządzenia stacjonarne

ESPRIMO PC Portfolio



ALL-ROUND LINE

Standard Applications

ADVANCED LINE

Complex Applications

SUPERIOR LINE

High Performance, Manageable Computing



Q520

A525-L

E/P420

E/P520

C720

E/P720

Q920

X923 / X923-T

C910-L/P910-L

E/P920

- Mini PC (< 2 liters)
- Compact design for a tidy desk
- DeskView Manageability
- Lowest noise and energy consumption
- High-efficient, integrated power supply
- Low Power Active Mode enables UC&C scenarios

- Thin PC
- Compact design for a tidy desk
- High-efficient power supply reduces the energy bill
- Fanless cooling for increased productivity
- Lifecycle up to 24 months

- Small form factor / Microtower
- Flexible configurations
- Best price-/ performance ratio with pre- configured variants

- Small form factor / Microtower
- DeskView Manageability
- Flexible configurations

- Ultra small form factor (7.4 liters)
- Compact design for flexible configurations
- DeskView Manageability combined with Intel® Standard Manageability
- Up to 90% energy efficient PSU
- 2 powered serial ports

- Small form factor / Microtower
- DeskView Manageability combined with Intel® Standard Manageability
- Up to 92% energy efficient power supply

- Mini PC (< 2 liters)
- Compact design for a tidy desk
- DeskView Manageability combined with Intel® vPro™ technology
- High-efficient, integrated power supply
- Lowest noise and energy consumption
- Low Power Active Mode enables UC&C scenarios
- Integrated VESA mounting

- All-in-one
- DeskView Manageability combined with Intel® vPro™ technology
- High-efficient, integrated power supply
- Lowest noise and energy consumption
- Touch option
- Integrated multimedia module (option)
- Low Power Active Mode enables UC&C scenarios

- Ultra small form factor / Microtower
- DeskView Manageability combined with Intel® vPro™ technology
- Up to 90% energy efficient power supply
- Lowest noise and energy consumption
- Supports extended usage scenarios, optimized for 24/7 operations
- Microsoft® Windows® XP driver support
- Lifecycle up to 24 months

- Small form factor / Microtower
- DeskView Manageability combined with Intel® vPro™ technology
- Up to 94% energy efficient power supplies
- 0-Watt functionality (option)
- Zero Noise (option)

CELSIUS Workstation Portfolio



Mobile Workstation



CELSIUS H730

- 39.6 cm (15.6-inch)
- Up to Intel® Core™ i7 with vPro™ technology
- Professional NVIDIA® Quadro® graphics
- Modular bay for additional battery time and 2nd hard drive
- Optional PalmSecure™ or fingerprint sensor
- Up to 32 GB memory

Desktop Workstations *

Long Lifecycle



CELSIUS W520

- Entry-level single-processor workstation
- Additional PCI and HDD expandability
- Cold plug access
- Long lifecycle of up to 48 months with Microsoft® Windows XP driver support
- Up to 32 GB memory



CELSIUS W530

- Entry-level single-processor workstation
- Ideal for entry-level CAD
- Choice of AMD and NVIDIA professional graphic cards
- Whisper quiet: 18 dB(A)
- Up to 32 GB memory



CELSIUS M740

- High-end single processor workstation
- Ideal for demanding CAD and CAE applications
- Support for up to two ultra-high-end graphics
- Support for up to 8 hard drives
- Medical certification (M740power)
- Up to 256 GB memory



CELSIUS R940

- High-end, dual processor workstation
- Ideal for demanding computing and memory-intensive multi-threaded applications
- Support for up to 3 ultra-high-end graphics
- Support for compute and coprocessor cards
- Up to 1 TB memory

Rack Workstation*



CELSIUS C620

- Full workstation performance packed in only 1U
- Ideal for 1:1 remote access
- Up to 32 GB memory
- Limited server manageability



CELSIUS C740

- Full workstation performance packed in only 1U
- Ideal for 1:1 remote access, GPU pass-through and 1:many graphics virtualization
- Fujitsu SSD PCI up to 512 GB
- Up to 256 GB memory
- Full server manageability

*designed and manufactured in Germany

LIFEBOOK Notebooks Portfolio



ALL-ROUND LINE

Standard Home & Office Application



LIFEBOOK

A514*

39.6 cm
(15.6-inch)
From 2.4 kg

- Anti-glare HD display non-touch
- Keyboard with NumPad
- Integrated WLAN and Bluetooth
- Webcam with status LED
- Computrace enabled BIOS



LIFEBOOK

A555
A555G *

39.6 cm
(15.6-inch)
From 2.4 kg

- Anti-glare HD display non-touch
- Keyboard with NumPad
- Integrated WLAN and Bluetooth
- Web cam with status LED
- Computrace enabled BIOS
- LIFEBOOK A555G
 - Discrete graphics
 - FHD display

ADVANCED LINE

Mobile Office for Corporate Demands



LIFEBOOK

E544

35.6 cm
(14-inch)
From 1.9 kg

- FHD or HD+ display anti-glare non-touch
- Family concept
- Common port replicator with LIFEBOOK E7 series
- Modular Bay
- 4G/LTE or 3G/UMTS
- Enterprise security



LIFEBOOK

E554

39.6 cm
(15.6-inch)
From 2.2 kg

- FHD or HD+ display anti-glare non-touch
- Family concept
- Common port replicator with LIFEBOOK E5 series and LIFEBOOK U745
- Modular Bay with 2nd battery option
- 4G/LTE or 3G/UMTS
- Enterprise security
- Magnesium lid, aluminum palm rest



LIFEBOOK

E734

33.8 cm
(13.3-inch)
From 1.6 kg

- FHD or HD+ display anti-glare non-touch
- Family concept
- Common port replicator with LIFEBOOK E5 series and LIFEBOOK U745
- Modular Bay with 2nd battery option
- 4G/LTE or 3G/UMTS
- Enterprise security
- Magnesium lid, aluminum palm rest



LIFEBOOK

E744

35.6 cm
(14-inch)
From 1.7 kg



LIFEBOOK

E754

39.6 cm
(15.6-inch)
From 1.9 kg



LIFEBOOK

U745

35.6 cm
(14-inch)
From 1.55 kg

- Ultrabook™
- HD+ display anti-glare with touch option
- Common port replicator with LIFEBOOK E
- Integrated VGA, exchangeable battery
- 4G/LTE or 3G/UMTS pull-out LAN
- Ultimate security with palm vein sensor option
- Magnesium housing, aluminum palm rest

SUPERIOR LINE

Ultimate Computing for Individual Needs



LIFEBOOK

S935

33.8cm
(13.3-inch)
From 1.24 kg

- WQHD or FHD display, anti-glare or touch option
- Extended battery runtime, Anytime USB Charge
- Common port replicator with LIFEBOOK E
- Integrated VGA, exchangeable battery
- 4G/LTE or 3G/UMTS pull-out LAN
- Ultimate security with palm vein sensor option
- Magnesium lid



LIFEBOOK

U904

35.6 cm
(14-inch)
From 1.33 kg

- WQHD+ display anti-glare or touch option
- Extended battery runtime, Anytime USB Charge
- 4G/LTE or 3G/UMTS pull-out LAN, WLAN, pull-out LAN
- Ultimate security with palm vein sensor option
- Magnesium housing, aluminum palm rest

STYLISTIC, LIFEBOOK Tablet Portfolio

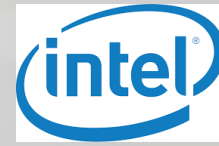

2 IN 1

Flexible Mobile Office

BUSINESS SPECIALIZED

For Business and Private Use

For Highly Mobilized Roles



STYLISTIC

Q584
Black Edition

25.7 cm
(10.1-inch)
From 640 g

- Super light 2 in 1 office tablet
- Extra bright, with WQXGA resolution
- Dual digitizer
- 4G/LTE
- Ultimate security
- Attachable keyboard option
- Windows 8.1

STYLISTIC

Q555* 

25.7 cm
(10.1-inch)
From 655 g

- Thin & light 2 in 1 hybrid tablet
- Dual digitizer
- Anti-glare display
- WUXGA resolution
- 4G/LTE and NFC
- Ultimate security
- Windows 8.1

STYLISTIC

Q775* 

33.8 cm
(13.3-inch)
From 980 g

- Captivating 2 in 1
- Full HD anti-glare display
- Dual digitizer
- Optional 4G/LTE, GPS, NFC
- Enterprise security
- Windows 8.1

LIFEBOOK

T725 

31.8 cm
(12.5-inch)
From 1.8 kg

- Sleek 2 in 1 Convertible
- HD resolution
- Dual digitizer
- Anti-glare display
- Optional 4G/LTE
- Enterprise security
- Modular bay concept
- Windows 8.1

LIFEBOOK

T935 

33.8 cm
(13.3-inch)
From 1.6 kg

- Ultra-thin 2 in 1 Convertible
- WQHD resolution
- Dual digitizer
- Optional 4G/LTE
- Best-in-class security
- Aluminum housing, magnesium lid
- Backlit keyboard
- Windows 8.1



STYLISTIC

Q572 

25.7 cm
(10.1-inch)
From 820 g

- Professional tablet
- Dual digitizer
- Anti-glare display
- Optional 4G/LTE
- Ultimate security
- Windows 8



STYLISTIC

V535 Industrial

21.0 cm
(8.3-inch)
From 540 g

- Fully rugged tablet
- Water- and dust resistant
- Drop resistant
- WUXGA resolution
- Multiple Touch with glove support and passive pen
- 4G/LTE, GPS, GLONASS and NFC options
- Cradle option
- Smart Shell Concept for industry-specific requirements
- Windows 8.1



STYLISTIC

Q704

31.8 cm
(12.5-inch)
From 980 g

- Semi-ruggedized tablet
- Water- and dustproof
- Extra bright, with Full HD resolution
- Dual digitizer
- Optional 4G/LTE and NFC
- Ultimate security
- Dual performance mode for extra long battery runtime
- Magnesium housing
- Shell Concept and keyboard option
- Windows 8.1

FUJITSU Server Enterprise Products



Odpowiednia kombinacja hardware, rozwiązań i know-how, która gwarantuje maksymalną produktywność, wydajność i elastyczność środowiska, oferując najwyższą niezawodność na rynku.

FUJITSU Server PRIMERGY

Kompletne portfolio wiodących rozwiązań x86 dla organizacji dowolnej wielkości.



FUJITSU Server PRIMEQUEST

Ekonomiczne benefity technologii x86 wsparte zaawansowanymi technologiami ze świata serwerów RISC. In-memory computing, x86 mission-critical uptime.



FUJITSU SPARC Servers

Modularność, skalowalność do 64 procesorów w kombinacji z najbardziej zaawansowaną architekturą RAS.



FUJITSU Storage Portfolio

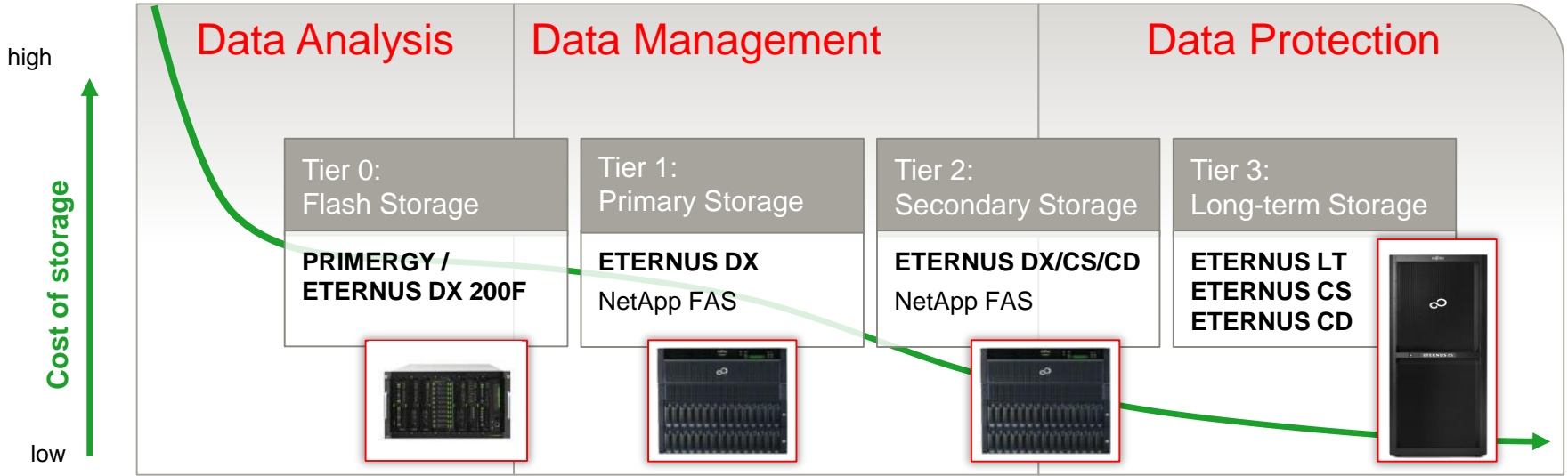

Age	nanosec.	sec.	hours	0 days	30+ days	90+ days	1+ years	Infinite
RTO	dismiss	microseconds	milliseconds	seconds	minutes	hours	days	
Cost per TB	CPU Cache (L3) €120Mio	DRAM €30K	Flash SLC €15K	SSD €13K	SAS €600	NL SAS €300	BC SATA €220	Tape €20

A grayscale silhouette of a person's head and neck in profile, facing right. The background is a blurred city skyline at night, with lights from buildings creating a bokeh effect. The text is overlaid on the silhouette.

Dlaczego serwery Fujitsu PRIMERGY i
PRIMEQUEST?

Dlaczego macierze Fujitsu ETERNUS?

Dlaczego PRIMERGY? Dlaczego ETERNUS?



■ Inżynieria, rozwój, testy, produkcja

- Niemcy: Paderborn, Augsburg
- Japonia: Tokyo, Sapporo, Kawasaki

■ Pełna kontrola nad procesem projektowania i produkcji

- własne fabryki i laboratoria badawcze optymalizacja projektu technicznego
- własne płyty główne, własne narzędzia do zarządzania
- dostawy zmontowanych systemów (szafy rack) do Klienta w cenie

■ Jakość Fujitsu

- szczegółowa „do bólu” kontrola jakości komponentów
- **100% produkcji Fujitsu testowana** - „Delivery for Zero Dead-on-Arrivals”
- Jedyne producent, który podaje MTBF konkretnych konfiguracji
- Niska awaryjność – niski koszt serwisu
- Serwisy z **gwarantowanym czasem naprawy & autocal** w bardzo niskiej cenie



FUJITSU Server Enterprise Products



Odpowiednia kombinacja hardware, rozwiązań i know-how, która gwarantuje maksymalną produktywność, wydajność i elastyczność środowiska, oferując najwyższą niezawodność na rynku.

FUJITSU Server PRIMERGY

Kompletne portfolio wiodących rozwiązań x86 dla organizacji dowolnej wielkości.



FUJITSU Server PRIMEQUEST

Ekonomiczne benefity technologii x86 wsparte zaawansowanymi technologiami ze świata serwerów RISC. In-memory computing, x86 mission-critical uptime.



FUJITSU SPARC Servers

Modularność, skalowalność do 64 procesorów w kombinacji z najbardziej zaawansowaną architekturą RAS.



Industry's most complete x86-based portfolio



One size does not fit all: To be able to meet the requirements for companies of all sizes, Fujitsu offers industry's most complete portfolio of industry standard x86 servers.



PRIMERGY TX Family

Expandable tower servers ideal for branch offices, remote offices and small businesses



PRIMERGY RX Family

Versatile and scalable rack-optimized servers with leading efficiency and performance



PRIMERGY BX Family

Platform for converged infrastructures designed to reduce IT costs, time and efforts



PRIMERGY CX Family

Density optimized cloud server infrastructures for HPC, cloud and hyper-converged computing

FUJITSU Server PRIMERGY Tower Systems



Robust and cost-efficient servers for SMEs and branch offices

- Affordable and expandable tower servers
- Simple operation, low power consumption and quiet operation
- Ideal for branch offices, remote offices and small businesses
- **Rack conversion kits** ensure investment protection



TX1310

Enter the world of PRIMERGY TX servers



TX1320

For small environments with high demands



TX1330

Expandable all-round server for SMEs



TX150

The one-processor tower server - maximized!



TX2540

Well-balanced price-performance



TX2560

Reliable performance for your business

Mono Socket

Dual Socket

FUJITSU Server PRIMERGY Rack Systems



Versatile, scalable servers with top performance

- The datacenter standard
- Versatile and scalable rack-optimized servers
- Leading energy-efficiency and performance



RX1330

Small in size,
low in cost -
rich in optional
features

Mono Socket



RX2520

Balanced
performance
and scalability

Dual Socket



RX2530

Maximum
productivity in a
1U housing



RX200

Maximum
productivity in a
1U housing



RX2540

The data center
standard



RX300

The versatile
2U power-
house



RX2560

Maximum
expanda-
bility
in a 2 way
server



RX4770

Superior levels
of performance
and system
reliability

Quad Socket

FUJITSU Server PRIMERGY Blade Systems



Platform to build a converged infrastructure designed to reduce time and efforts

- Datacenter in a box with all infrastructure-, network and management components
- Improved manageability, availability, and operational efficiency from shared cable infrastructure and virtual input/output (I/O)



BX400

Affordable blade technology for medium-sized businesses

Blade Chassis



BX900

Dynamic server infrastructure designed for high requirements



BX2560

Universal server blade

Server Blades



BX2580

High performance blade helping to cope with the most demanding workloads



BX924

Maximum scalability for demanding applications



SX960

SX980

Direct-attached and centralized storage

Storage Blades



1/10/40 Gbit/s Ethernet
8/16 Gbit/s FC
10 Gbit/s DCB (FCoE)
56 Gbit/s IB
6 Gb/s SAS

Connection Blades

Fujitsu PRIMERGY BX900 S2 | Front View



10 U chassis for 19-inch rack

Up to six (6) HDD Storage Blades, or Tape Storage Blades



Up **18 server blades** in 2 rows for different types of server and storage blades

Local Service Display (LSB) for basic management tasks and initial installation (Base Configuration Wizard)

The PRIMERGY BX900 has space for up to 18 server and storage blades in a 10U chassis. Thus it's the leader in its class for density in a compact form factor.

FUJITSU Server PRIMERGY Scale-out Systems



Platform for cloud, HPC, and large scale-out computing

- Density optimized cloud server infrastructures
- More computing power in less space
- Lower costs for energy due to shared power & cooling



CX400

Compact server node density with high power efficiency to realize large scale-out solutions for HPC and cloud computing at lower overall costs

Chassis



CX420

Out-of-the-box cluster server enabling small and medium enterprises to provide continuous uptime for their business applications and data



CX2550

Dual socket server node in a highly condensed half-wide, 1U form factor

Server Nodes



CX2570

Dual socket server node for ambitious high performance computing, analytics and visualization solutions

FUJITSU Server PRIMEQUEST Systems



Scalable platform for business-critical and mission-critical workloads

- New levels of x86 server performance for in-memory computing and resource-intensive applications
- UNIX-matching high-availability features with x86 cost efficiency



PQ2800B

8-socket enterprise platform with enhanced RAS features and extra-large memory capacities to handle bigger memory-intensive applications

Business-Critical



PQ2400E

Top-of-the-range 4- and 8-socket systems with unique mission critical features for error preventions and self-healing capabilities while delivering a flexible computing resource pool with features like Dynamic Reconfiguration.

Mission-Critical



PQ2800E

Fujitsu PRIMEQUEST 2800E2



8 socket 10U Rack Server: No Time for Downtime

Feature Overview

- Operational efficiency
 - Unity of x86 efficiency and flexibility with enterprise high availability
 - Eliminate costs related to the UNIX world
 - New levels of energy efficiency
- **Mission-critical RAS features**
 - Physical Partitioning
 - Active reserve system board
 - Flexible I/O ensure available of PCIe devices
 - Almost everything is redundant
- Dynamic platform for demanding datacenter
 - 8x Intel Xeon processor E7-8800 v3 product family
 - Up to 12TB memory and 144 cores
 - Business centric use thanks to new Dynamic Reconfiguration of resources without need for restart



Usage Scenarios

Mission
critical apps

Real time
analysis

Large scale
databases

Server
consolidation

PQ 2x00E2 - Supported Partition Types

	Physical Partition (PPAR)	Extended Partition	Software Partition (Hypervisor)
Isolation layer	Hardware	Hardware/Firmware	Hypervisor
Key point	High reliability and performance	Dense consolidation with reasonable reliability	High density consolidation
Fault tolerance	<p>Application level: Application errors don't affect other partitions.</p> <p>Firmware level: F/W errors don't affect others</p> <p>Hardware level: H/W errors don't affect others</p> <p>Most H/W errors are contained in partitions; ex. DIMM, and I/O.</p>		
Flexibility	Configurable with H/W component granularity; system board, IOU, etc.	Configurable with device granularity; PCI slot, CPU core, DIMM, etc.	Configurable with percentage of H/W resources; 10% of CPU core, etc.
Block diagram			

PRIMEQUEST 2x00E2

Physical Partition (PPAR)

■ Physical Partitioning (PPAR), provides multiple Physical Partition blocks in one cabinet

- A different OS can be operated in each partition
- The partitions can be configured flexibly by using flexible I/O and reserved SBs
- Multiple workloads can be operated in a single cabinet, supported thru
 - Multiple servers operated as Physical Partition
 - or extended Partition
- A failure in one partition, doesn't affect the others

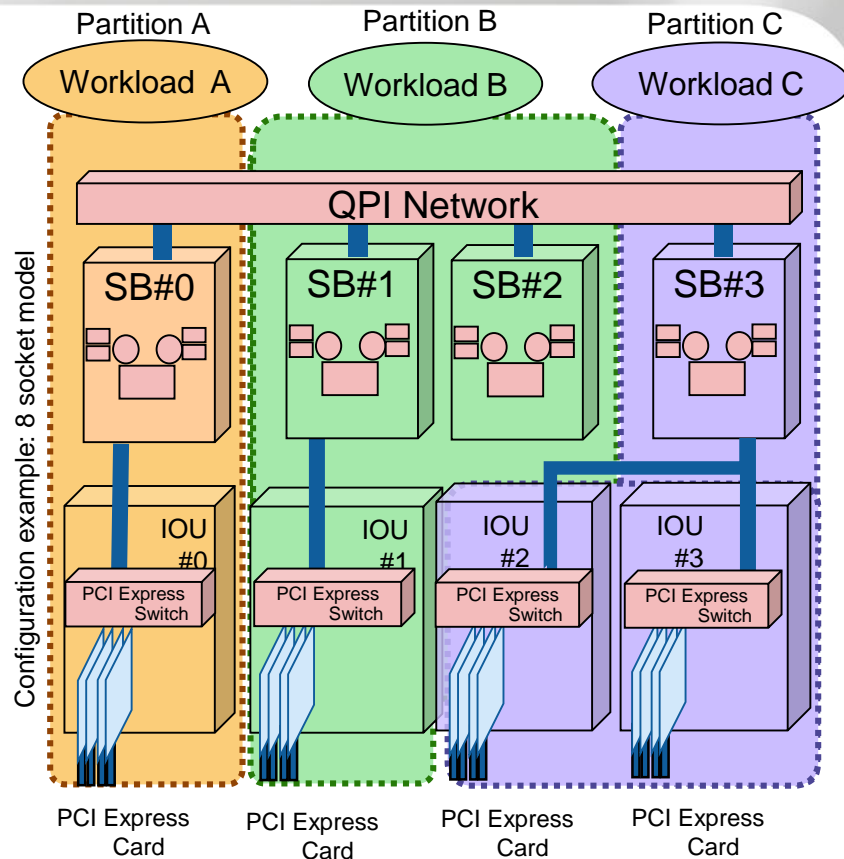

Ensure business continuity



Reserved System Board

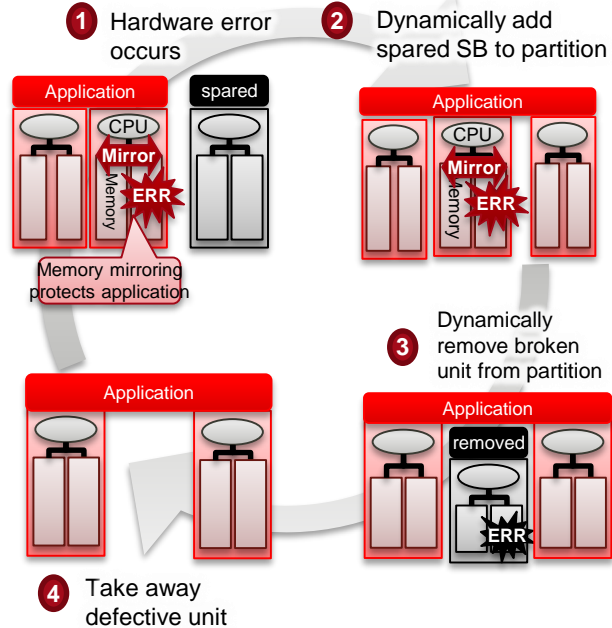

Mission-critical features

- Replace defective hardware unit without stopping applications
- Enable maintenance “on-the-fly”
- Reserved SB can be used for other workloads
- Isolated hardware partitions: Failures in a partition do not affect other partitions

Benefits

- Outstanding platform reliability
- Automatically recovery of resources, applications & services
- System maintenance without downtime

FUJITSU Value Calculator



FUJITSU Value Calculator

FUJITSU servers provide the most powerful and flexible datacenter solutions for companies of all sizes, across all industries and for any type of workload.

Value Calculator >

Product Finder >

Portfolio Overview >

Resource Center >

■ Available for iOS / Android:

iOS:

<https://itunes.apple.com/us/app/fujitsu-value-calculator/id876378366>

Android:

<https://play.google.com/store/apps/details?id=de.unilab.fujitsuvaluecalculator>



Fujitsu PRIMERGY – serwery „bogate z domu”



Chłodzenie

- **Nadmiarowość w standardzie**
(z zasilaczami hotplug)
- Podłączanie podczas pracy/latwa wymiana

Pamięć

- Advanced ECC
- Rezerwa aktywna, kopie lustrzane
- Scrubbing, SDDC itd.

Zasilacze:

- Nadmiarowość
- HotPlug
- **Sprawność energetyczna min. 94% (Platinum) w standardzie**, opcja 96%
- **Power SafeGuard**

Dyski HDD / SSD

- **Zawsze dyski Hot Plug**
- Elastyczny wybór baseunit

Zarządzanie

- Pełna karta zarządzająca **IRMC S4 w standardzie**
- **eLCM (z kartą SD)**
- **Zdalny serwis**
(proaktywny – od 6.2015)

Temperatura

- Własne płyty główne
- Dynamiczny pomiar i kontrola
- Czujniki temperatury **ATD Cool-safe™**

- UFM Integrated Virtualizator slot
- SATA DOM onboard SSD

Technologia **DynamicLOM**

Kontrolery dysków SAS 3.0

- Szeroki wybór kontrolerów
- Kontroler onboard dla podstawowych konfiguracji
- Funkcja FBU

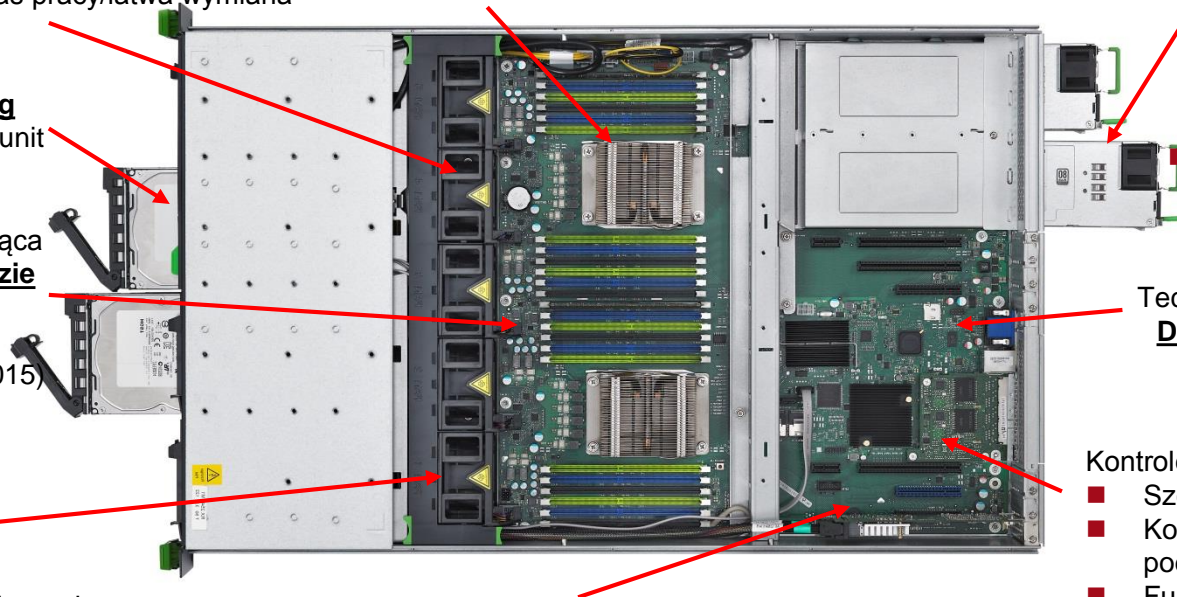

*Nie dotyczy TX1310

Elastyczność konfiguracji baseunit – np. RX2540

3.5-inch hot-plug SAS/SATA

4x HDDs/SSDs

8x HDDs/SSDs

12x HDDs/SSDs

12x HDDs/SSDs
+ 4x 2,5 HDDs/SSDs

2.5-inch hot-plug SAS/SATA

8x HDDs/SSDs

16x HDDs/SSDs

24x HDDs/SSDs

24x HDDs/SSDs
+ 4x 2,5 HDDs/SSDs

4x / 8x / 12x 3.5" HDDs

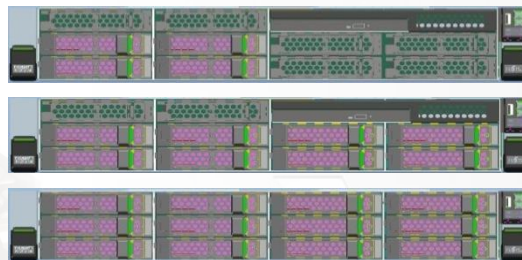

8x / 12x / 24x 2.5" HDDs

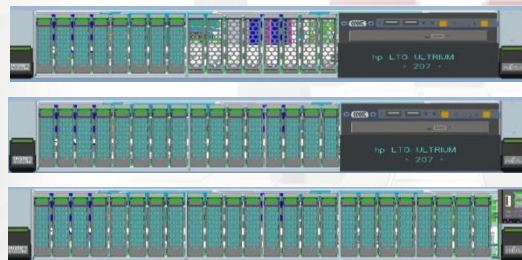

+ 4x 2.5" HDDs rear

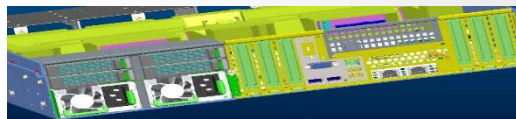

ServerView® - iRMC S4

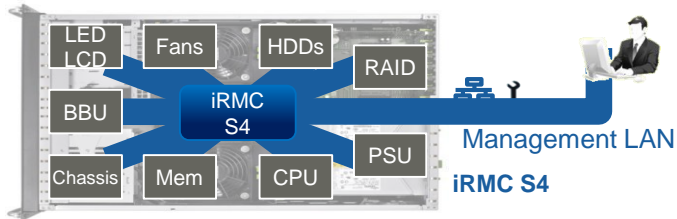

ServerView & iRMC S4 – at a glance

- Enhancement of monitoring capabilities
- New integration packs
- Improvements in power management features

eLCM with SD Card



Simplified, highly integrated and automated management processes.

Agent-less monitoring of HDDs and RAID controller



Enhanced admin experience and simplified management of daily tasks

Video Capturing*



Virtual Media* for multiple CD/DVD, HDD or FDD images or physical drives



Enables interchange of system infos between different mgmt systems

Support of Common Information Model (CIM)

* available as option

Your key to an efficient server operation

Wysoka jakość przez całe życie produktu



Fujitsu buduje kompletną linię serwerów PRIMERGY używając standardów jakościowych i doświadczeń znanych z rozwiązań serwerowych typu „mission critical”

- Standardy jakościowe PRIMERGY porównywalne do świata serwerów UNIX
 - Annual Failure Rate (AFR) dla PRIMERGY poniżej 0.095 na system
- Fujitsu jedynym producentem testującym 100% produkcji
- Fujitsu jedynym producentem IT który testuje sprzęt poprzez np.:
 - Aż 5,000 cykli Power On/Off & AC-fail tests dla najwyższych standardów komponentów
 - Testy fabryczne trwają 12h
- Patch management dożywotnio w cenie rozwiązania
 - Za darmo razem z pakietem ServerView
 - Karta zarządzająca IRMC S4 w standardzie
 - Pre-failure detection

Przykład – Fujitsu PRIMERGY TX150

- HW availability: **99.992%**
= 44 min unplanned downtime p.a.
- Operation time
 - calculated as 6 years by standard industry quality methods,
 - experienced as 10 years by field data collected
- Unique in class:
 - Hot-plug redundant PSUs, storage drives, RAID
 - Pre-failure Diagnosis & Analysis
 - Integrated service processor and ServerView Suite



Wysoka jakość przez całe życie produktu

Projektując serwery PRIMERGY Fujitsu skupia się na funkcjonalności, jakości i jakości w celu zapewnienia bezproblemowej pracy w całym życiu serwera

Najlepsze przykłady pochodzą od Klientów 😊

- PRIMERGY używane nawet w najcięższych warunkach
- 3 letni serwer PRIMERGY RX200 – do rozbudowy
- Bezproblemowa praca



A dark silhouette of a person's head and shoulders is shown in profile, facing right. The background is a grayscale image of a city skyline at night, with numerous illuminated buildings and a prominent skyscraper with two antennas. The overall image has a bokeh effect with soft, out-of-focus light spots.

Kilka słów o produktach...

Rozwiązania storage Fujitsu ETERNUS

Fujitsu Storage Portfolio - Business-centric Storage

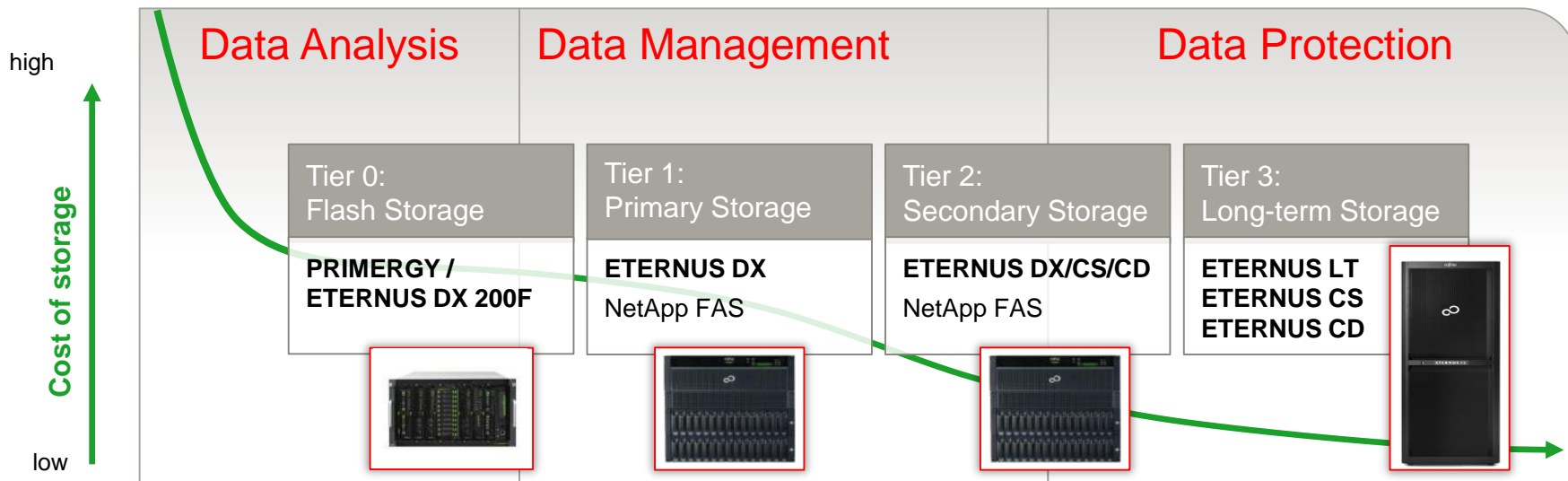

Age	nanosec.	sec.	hours	0 days	30+ days	90+ days	1+ years	Infinite
RTO	dismiss	microseconds	milliseconds	seconds	minutes	hours	days	
Cost per TB	CPU Cache (L3) €120Mio	DRAM €30K	Flash SLC €15K	SSD €13K	SAS €600	NL SAS €300	BC SATA €220	Tape €20

Fujitsu ETERNUS – zawsze dobry wybór



Accelerate!

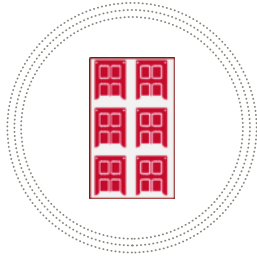

ETERNUS DX200F

Consolidate!



ETERNUS DX

Hyperscale!

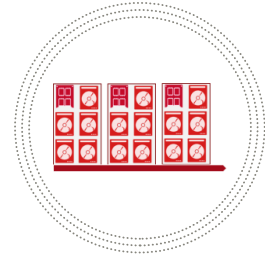

ETERNUS CD1000

Protect!

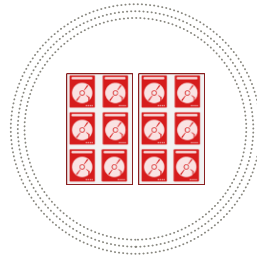

ETERNUS CS



ETERNUS LT

New scalable ETERNUS DX entry, midrange & highend systems



DX60 S3



DX100 S3



DX200 S3



DX500 S3



DX600 S3



DX8700/8900 S3

ETERNUS SF V16 storage management software

- Nowa „wydajnościowa” architektura, obsługa dostępu **blokowego i plikowego**, duże możliwości użycia i konsolidacji
- Segment Highend został zaprojektowany do ponad 3 Mio IOPS
- Zaawansowane funkcje zarządzania wspólne dla całej rodziny

ETERNUS DX – Wspólna architektura



entry-level



DX60

scalable entry-level



DX100



DX200

midrange



DX500



DX600

high-end



DX8700 & DX8900

ETERNUS SF V16 storage management software

- ➔ Wspólna rodzina
- ➔ Kompatybilne elementy, wspólny zunifikowany management



Same
mgmt.
SW



Same
disk
types



Same
disk
shelves

Elastyczna architektura rodziny macierzy ETERNUS

- ➔ Spójna koncepcja rodzinna macierzy ETERNUS DX
 - ETERNUS DX oferuje zaawansowane możliwości skalowania w każdym z modeli
 - ETERNUS DX umożliwia skalowanie przez upgrade do wyższego modelu z rodziny
- ➔ Maksymalna ochrona inwestycji, minimalne koszty operacyjne

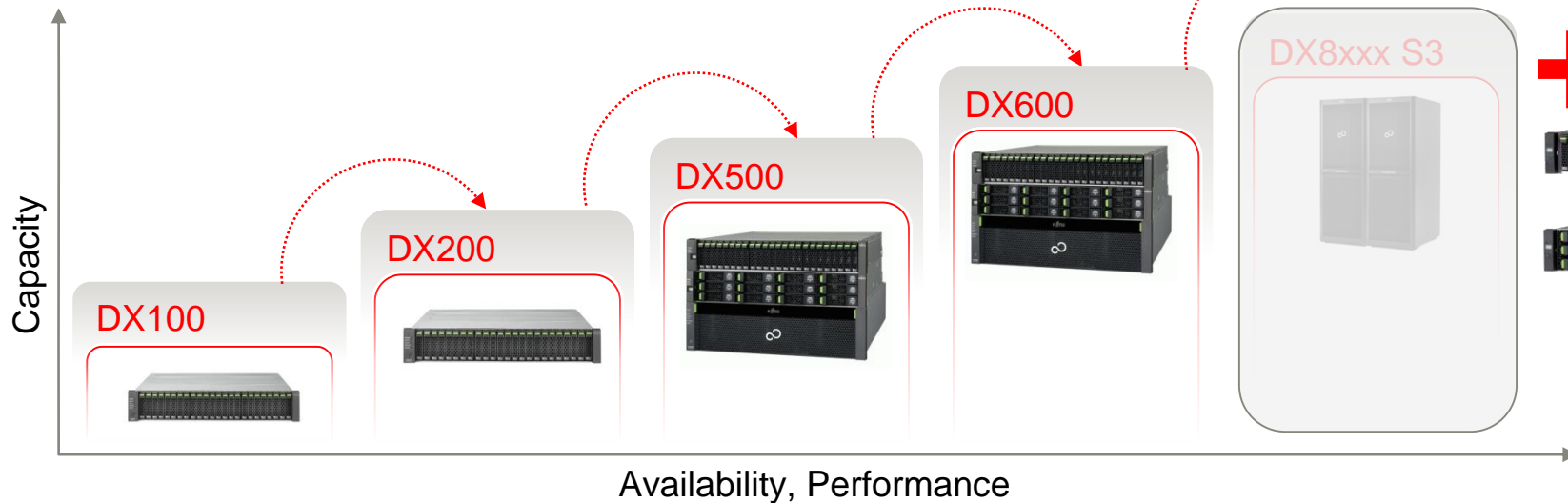

Delivering incredible SPC-1 results



Record breaking SPC benchmark results



ETERNUS DX200 S3

- Response time of 0.63 milliseconds under 100% load
- Highest IOPS for an entry storage
- Impressive price-performance ratio of \$0.77 / SPC-1 IOPS™



ETERNUS DX600 S3

- Best SPC-1 result for dual controller mid-range
- Response time of just 0.61 milliseconds under full load
- Outstanding price performance ratio of \$1.54/SPC-1IOPS™



Model	IOPS**	Response time (ms)
ETERNUS DX200 S3	200,000	0.63
ETERNUS DX600 S3	320,000	0.60

* Official results are available at: http://www.storageperformance.org/results/benchmark_results_spc1_active/#fujitsu_spc1

** Input/Output performance per second



[SPC benchmark summary sheet](#)

ETERNUS DX200 – SPC1 Benchmark



Summary of Results

SPC-1 Reported Data	
Tested Storage Product (TSP) Name: Fujitsu Storage Systems ETERNUS DX200 S3	
Metric	Reported Result
SPC-1 IOPS™	200,500.95 
SPC-1 Price-Performance™	\$0.77/SPC-1 IOPS™
Total ASU Capacity	3,280.000 GB
Data Protection Level	Protected 2 (<i>Mirroring</i>)
Total Price	\$154,005.32
Currency Used	U.S. Dollars
Target Country for availability, sales and support	USA

Response Time (ms)

IO Requests per Second

ETERNUS DX200 – SPC1 Benchmark

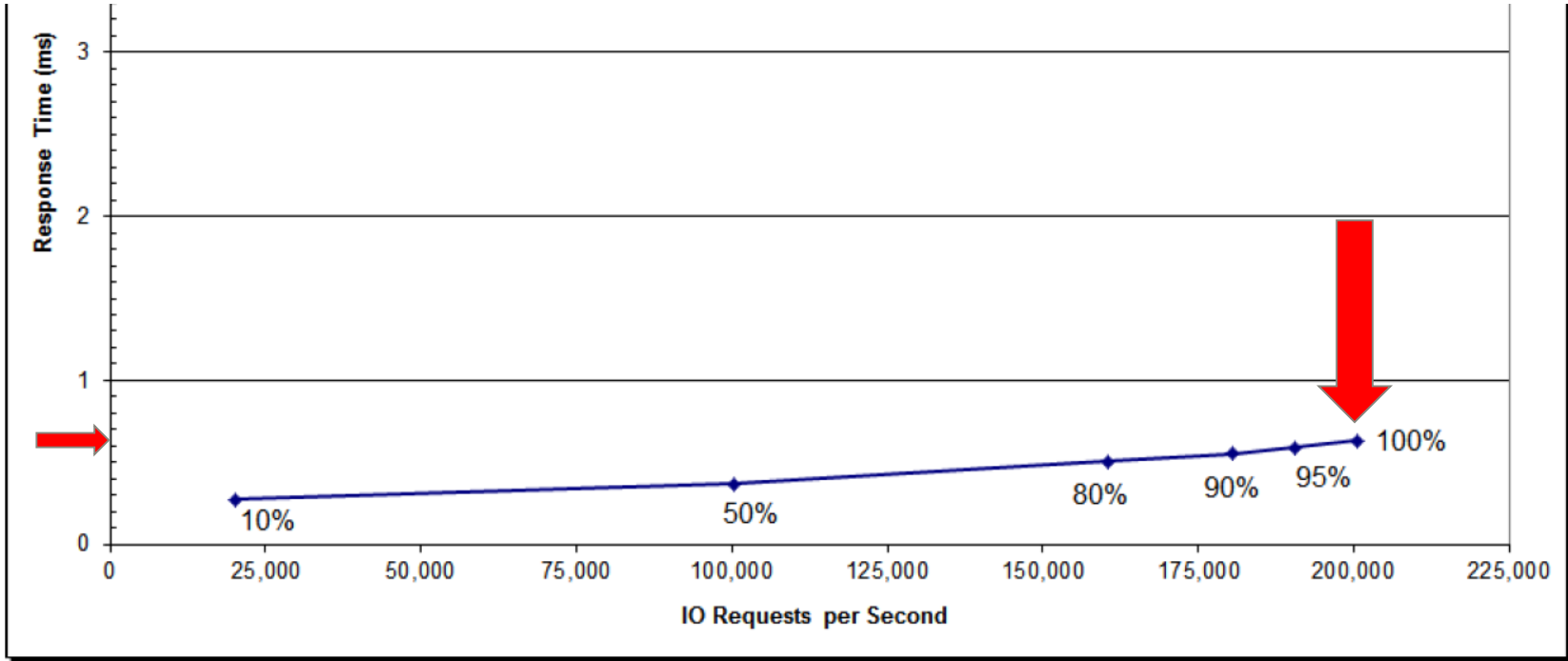

ETERNUS DX200F



Protocols

FC

FCoE

iSCSI

CIFS / NFS

INFINIBAND

Unified ETERNUS System Portfolio



Performance

- Architecture
- Flash technology
- Automation
- Optimization

Unified Management with ETERNUS SF

- Same hardware
- Same software
- Same people
- Same processes



Benefits

- Performance
- Efficiency
- Manageability



One Architecture for Consistent Operations

Niski koszt uruchomienia warstwy NAS

- Proste doinstalowanie komponentów (interfejsy, pamięć Cache) dedykowanych do obsługi NAS, bez obniżania jakości obsługi dla dotychczasowych Użytkowników w sieci FC/IP SAN
- Obsługa SAN/NAS z jednego i tego samego modułu kontrolerów, bez „rewolucji” w szafie instalacyjnej rack
- Pełne zarządzanie konfiguracji Unified tymi samymi narzędziami: WebGUI, CLI w macierzy, pakiet Eternus SF.

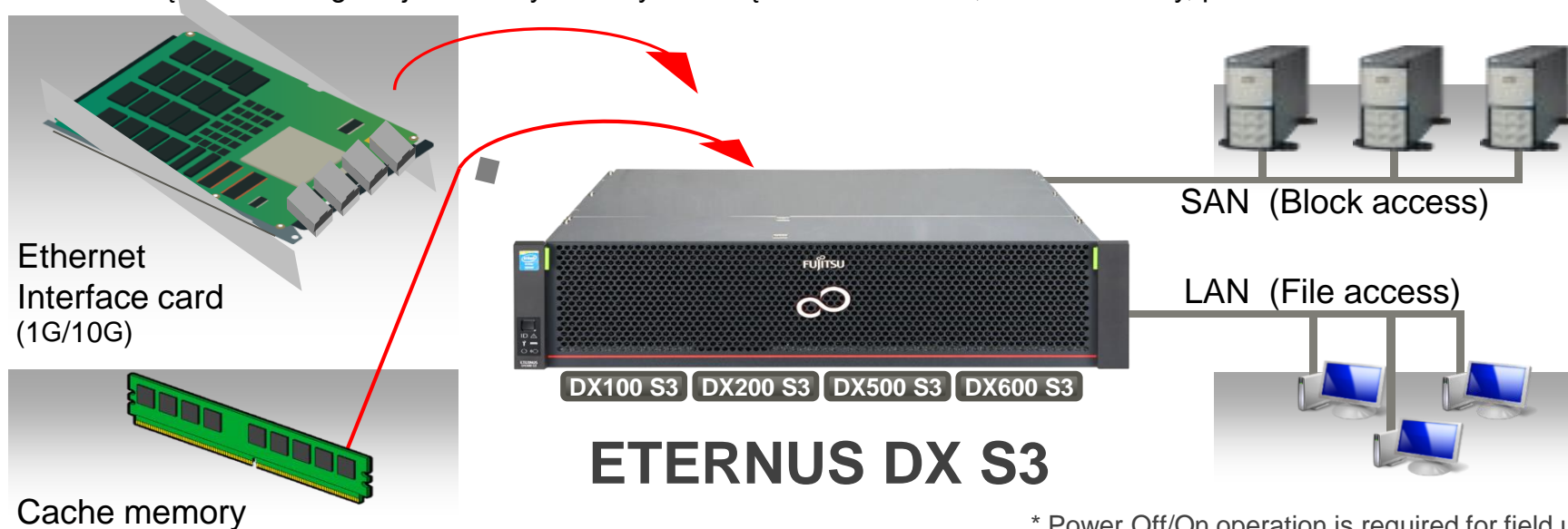

* Power Off/On operation is required for field upgrade.

- Ranking rozwiązań klasy Unified na niezależnych [stronach](#) WWW

Extreme Cache (&Extreme Cache Pool)

High speed/capacity PCIe SSD cache (Extreme Cache) in controllers

- High hit rate by high capacity cache
- High performance with less number of drives, low cost & power consumption

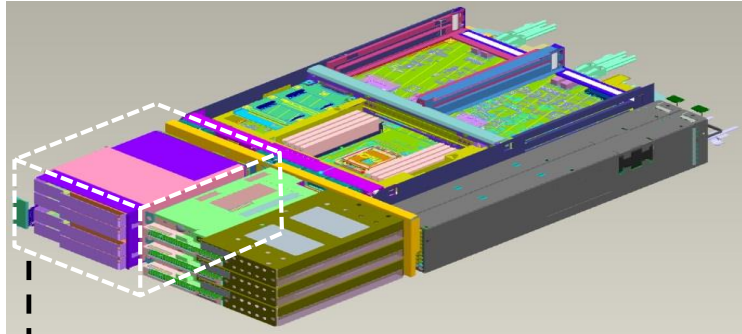

- - Extreme Cache
 - Mounted in Controller
 - Max. 5.6TB

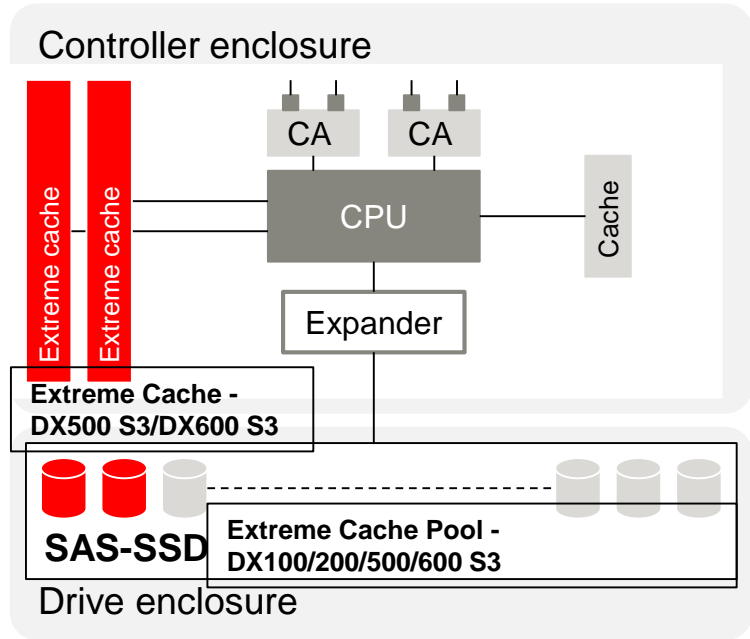

Optimal Data Allocation - Automated Storage Tiering



Optimal drive selection & automated data allocation improves performance and reduces cost

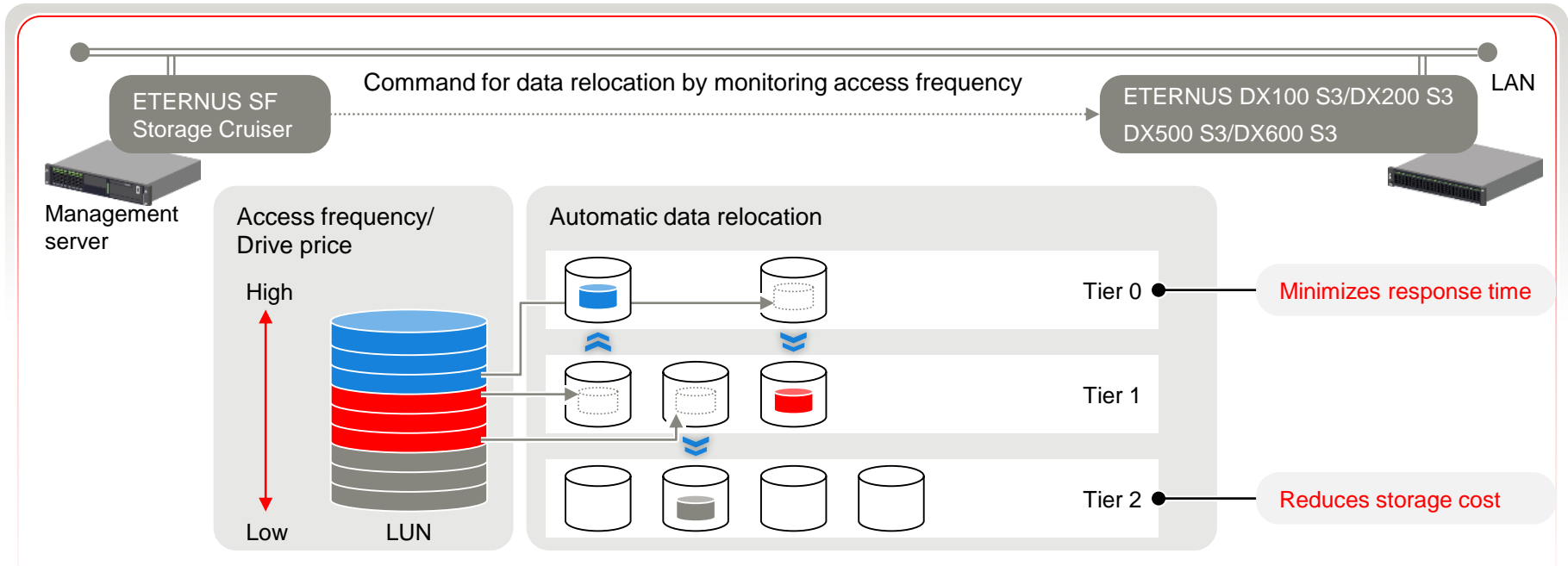

 Optimized to maximum efficiency with 252 MB Block Size

Automated Quality-of-Service management

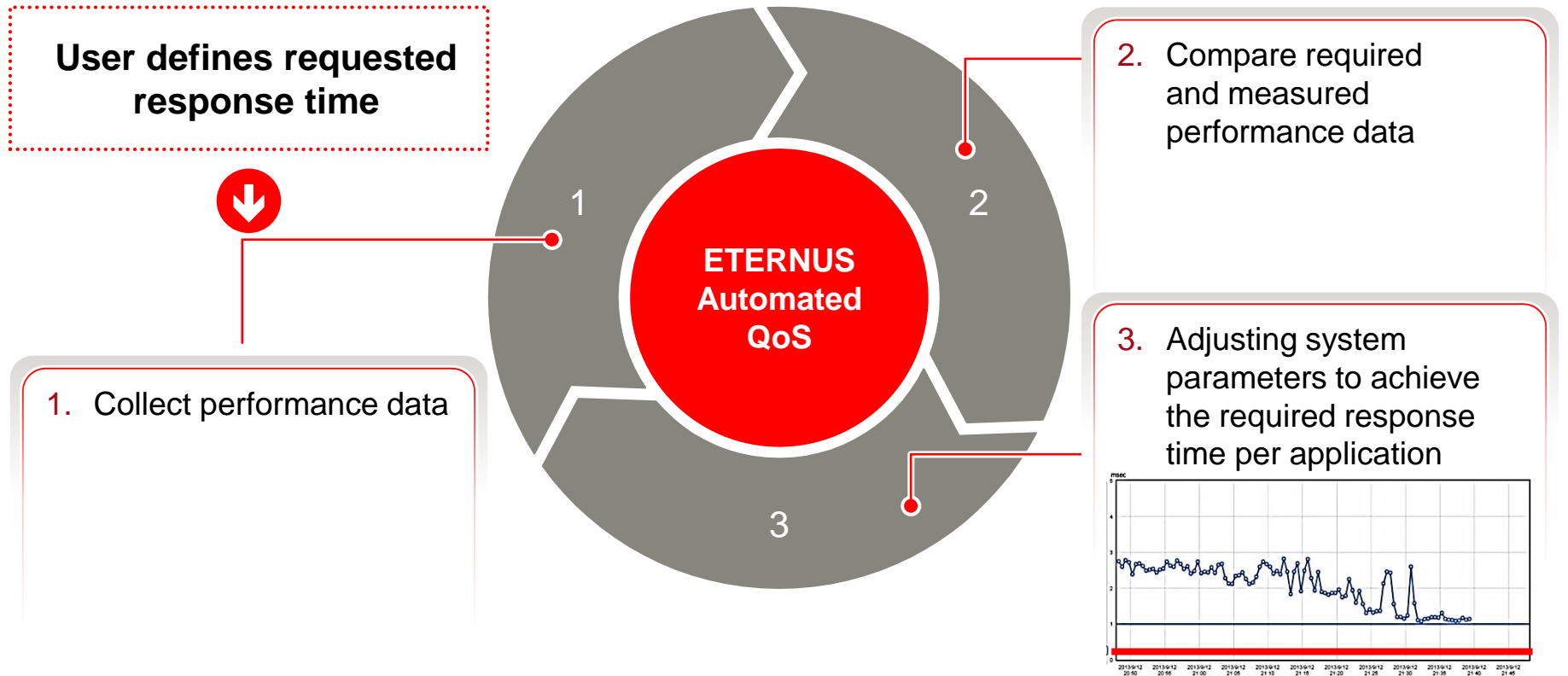

Replikacje 1:N, N:1, N:M po sieci LAN/WAN protokołem iSCSI

- Brak konieczności stosowania drogich konwerterów FC<>IP
- Konfiguracja sesji zdalnych replikacji danych z wykorzystaniem iSCSI 1Gb/s lub 10Gb/s

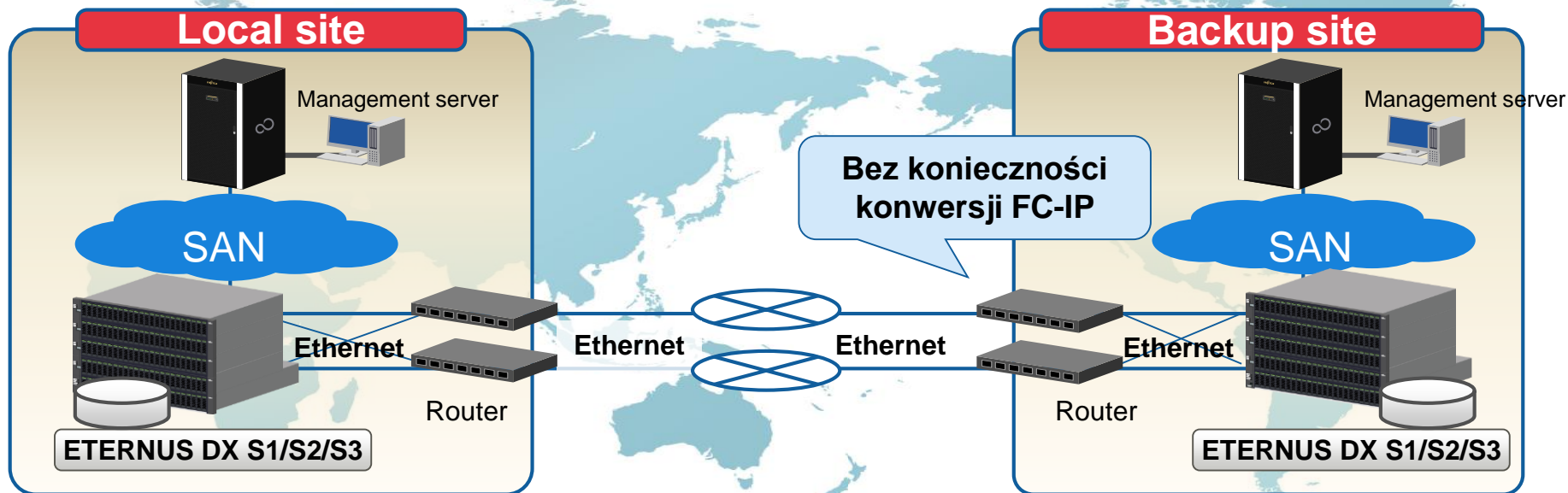

Transparent Failover- ETERNUS Storage Cluster

- ➔ W przypadku uszkodzenia podstawowej lokalizacji storage zapasowa macierz przejmuje tożsamość podstawowej (IDs)
- ➔ Komunikacja I/O jest kontynuowana transparentnie przez drugi system ETERNUS DX
- ➔ „Failover” może być wykonany w obydwu kierunkach i pomiędzy różnymi modelami ETERNUS DX
- ➔ Przełączenie automatyczne lub manualne
- ➔ Funkcjonalność sprzętowa

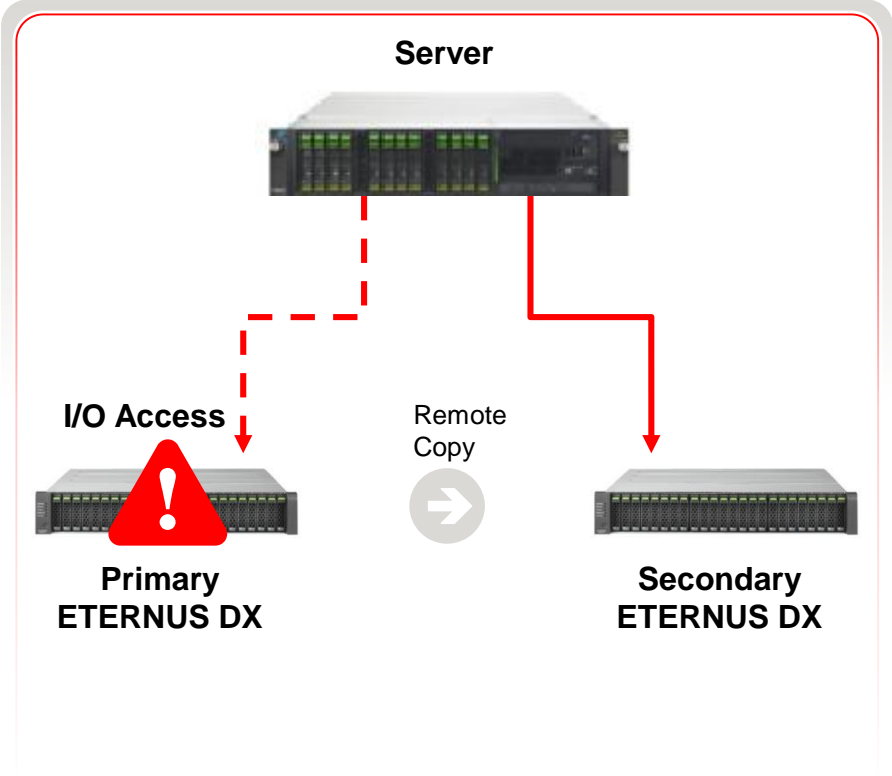



Oferta

- ETERNUS CS8000 – zunifikowana platforma do ochrony danych
- ETERNUS CS800 – appliance „backup to disc”
- ETERNUS CS200c – „All in one” storage appliance ze zintegrowanym software do backup

Jak wyróżnia się Fujitsu?

- Wiodąca skalowalność, automatyzacja, all-in-one (CS8000)
- Wiodąca łatwość wdrożenia, rozbudowy i funkcjonalności deduplikacji (CS800)
- Appliance „all-in-one” we współpracy CommVault Simpana (CS200c)

Którą technologię użyć?

Taśma



Dysk + deduplikacja



Dysk



Dysk - Taśma



Backup Methodologies

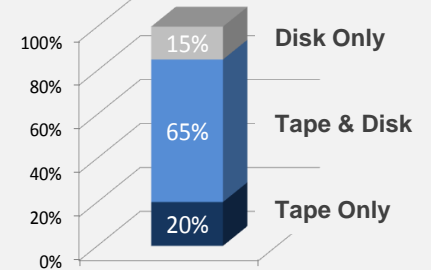

Koszt
Bezpieczeństwo

Pojemność
Wydajność

Wydajność

Wydajność
Koszt
Bezpieczeństwo

Integrated Backup Appliance – CS200c



X86 / Open Systems (Microsoft/ Linux/ Unix) – Physical or Virtual (VMWare / Hyper V)

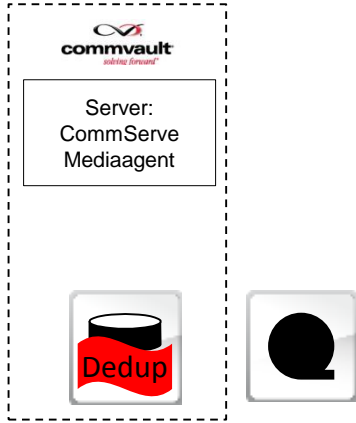

Solution / Service
(vertical/ horizontal)

ISV / Application

Infrastructure

- Server Platform
- Networks
- Storage

Backup Software

Integrated Backup Appliances

ETERNUS CS200c

Backup Software +
Backup Server +
Backup Target (Disk, Dedup option)
Option: Tape Backend

Fujitsu ETERNUS CS200c



■ Zintegrowany appliance Fujitsu (All in One)

- Kompletne rozwiązanie do ochrony, backupu i archiwizacji danych w pojedynczym pudełku
- **CommVault Simpana** „embedded”
- W pełni licencjonowany – pojemność backend
- Bez ograniczeń ilości agentów itp.
- Disk-to-Disk-to-Tape, Replikacja, etc
- Fujitsu - Pojedynczy punkt kontaktu i wsparcia dla całego rozwiązania
- Od 4 do 96 TB przed deduplikacją - elastyczność pojemności i funkcjonalności
- Możliwość łączenia kilku urządzeń
- CommVault Simpana Software dostępna bezpośrednio w Fujitsu



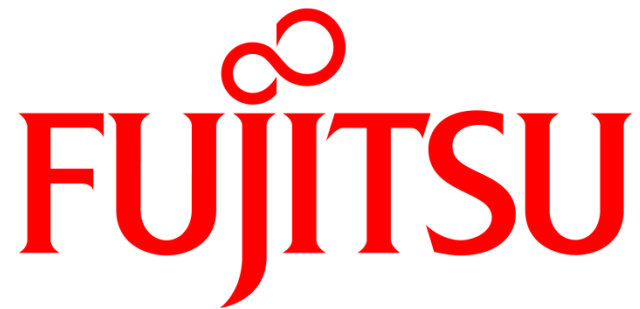

FUJITSU

shaping tomorrow with you